







Overview

| SYSTEM GROUP | GRID |
|---|---|
|  |  |
| Suspended Ceiling | Concealed Grid SAS J-Bar suspension |

| TILE | |
|---|---|
|  |  |
| Hook-on | Square edge |

| ACOUSTICS | |
|------------------|----------------|
| A-D | 15-41dB |
| Absorption class | Insulation |

| ACCESS | SYSTEM WEIGHT | LIFE EXPECTANCY |
|---|--|-----------------|
|  | 9kg/m² Approx. | 25yr |
| Full – Lift and swing down | Based on 1200 x 300mm tiles 30mm deep* | In excess of |

***Note** This includes the entire system and full associated components (suspension, tile, acoustic pad and associated fixings.)

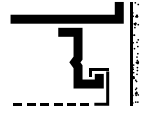

SAS205 is a SAS200 variant, designed specifically for corridor applications. The suspended ceiling system is supported at its perimeters, up to a maximum of 3000mm widths.

Areas requiring frequent access for maintenance, such as hospitals, residential-blocks and hotels are ideal applications. SAS205 is also commonly specified for commercial offices to blend seamlessly with other SAS suspended ceiling systems.

Module Sizes

There are no standard tile sizes for SAS205. Tiles can be up to 3000mm in length and no less than 300mm wide. Bespoke module sizes and shapes are available on request.

Access

Swing down and hang. Tiles can pivot on one edge to hang in place, offering full void access while keeping tiles safe from harm. This access method is subject to corridor height and width.

Finishes

SAS205 is available in all standard SAS finishes, please refer to page 105. Bespoke finishes are available on request.

Perforations

SAS205 can be manufactured with any standard SAS perforation. For our full range of perforations, please refer to page 83. Bespoke perforations are also an option.

Acoustic Materials

16mm deep, 80Kg density mineral wool pad with black tissue face, foil back and sides. Other acoustic materials are available, please refer to page 20.

Service Integration

Tiles can be formed with apertures during manufacturing and post painted for integration with lights and other services.

Please note Loads in excess of 6Kg require independent suspension.

Technical Support

Please contact our technical team for all questions relating to access, security, bespoke features, service integration or load support.

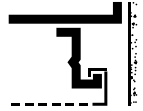

Perspective Drawing

- 1 Closure Angle Support
- 2 J-Bar
- 3 SAS 205 Tile

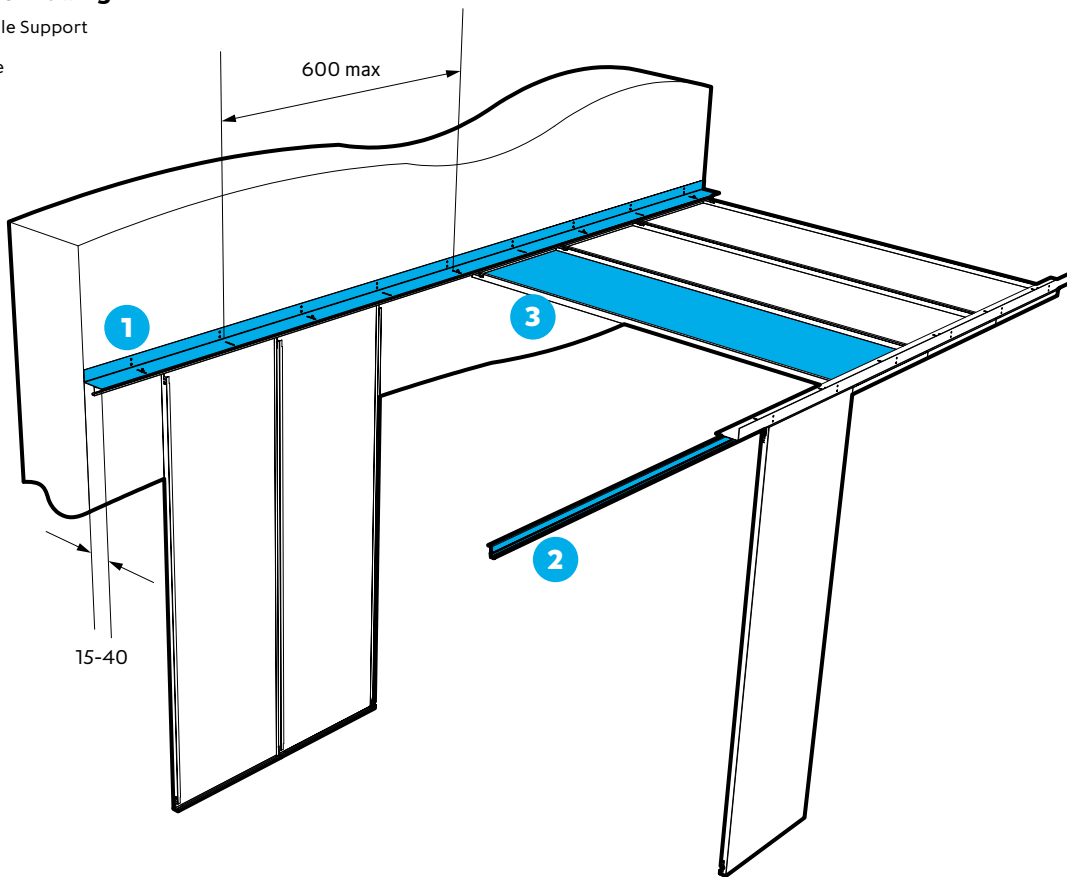

Section drawing

Overall construction depth

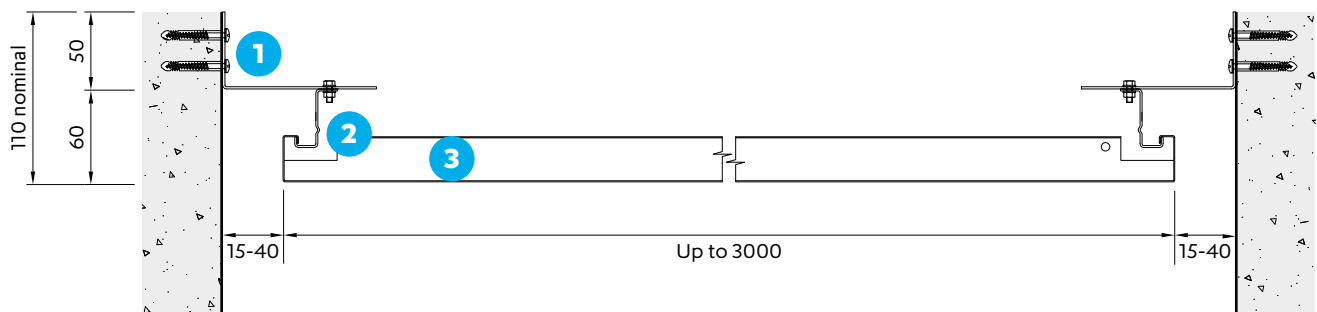

Swing Down Tile

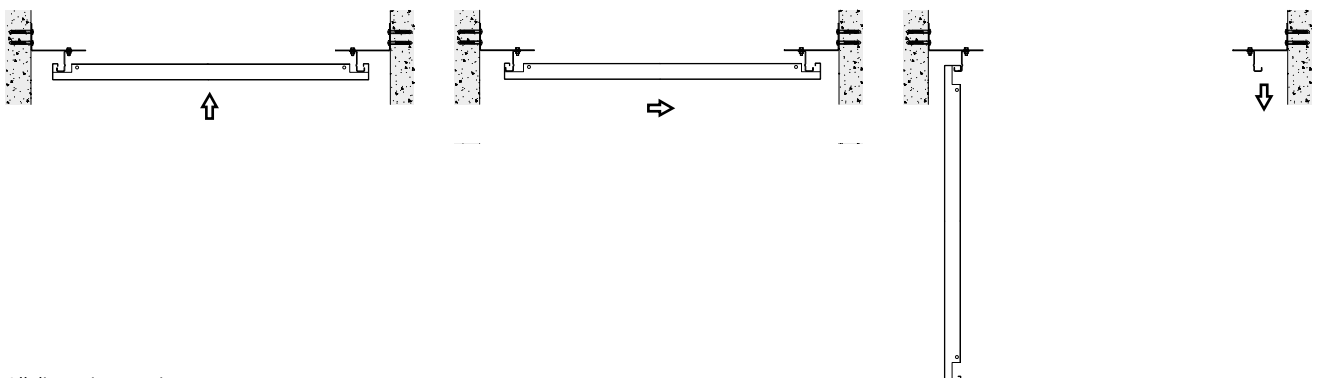

All dimensions are in mm.



SAS**205**

Hospital General de Asturias, Oviedo

Location
Oviedo, Spain
Architect
**Herraiz Arquitectura,
S.L./Navarro Baldeweg
Asociados S.L.P**

Contractor
**Constructora San Jose/
Sacyr Vallehermoso/
UTE Huca**
Purpose
Healthcare



SAS205

University of Technology, Sydney

Location
Sydney, Australia
Architect
BVN Architecture

Contractor
Richard Crookes
Construction
Purpose
Education

SAS PLUS

SAS Plus offers the system designer access to SAS' in-house design team to collaborate on bespoke ceiling specification. Systems can be variants of standard SAS offerings, or completely bespoke designs.

Call us for more details.

UK +44 (0) 1189 290 900

UK sasint.co.uk

enquiries@sasint.co.uk